

Cascaded Chemical Salts for Adsorption Heat Pumps

Oluyemi Jegede
School of Engineering,
University of Warwick

Singles Salts Vs Cascaded Salt

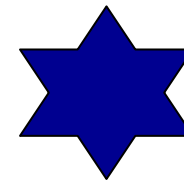
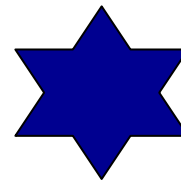
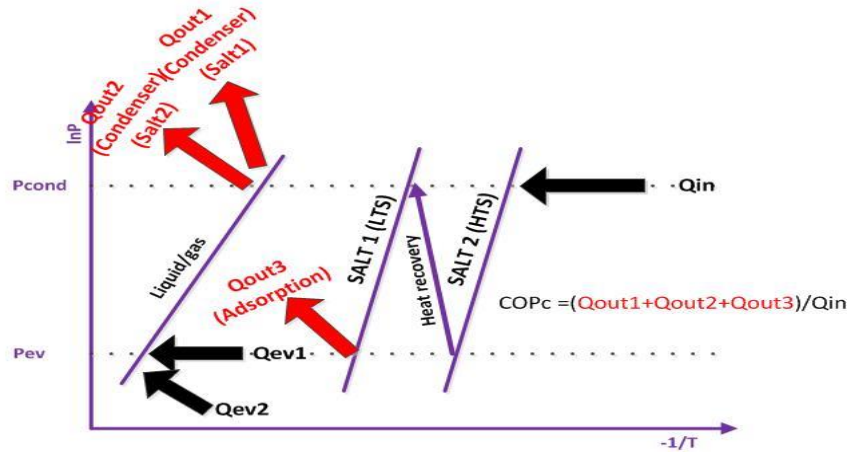
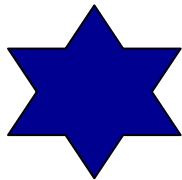
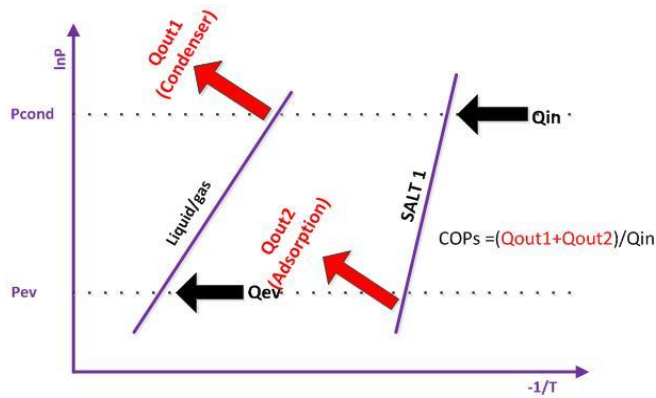

Till Date (Large Temperature Jump)

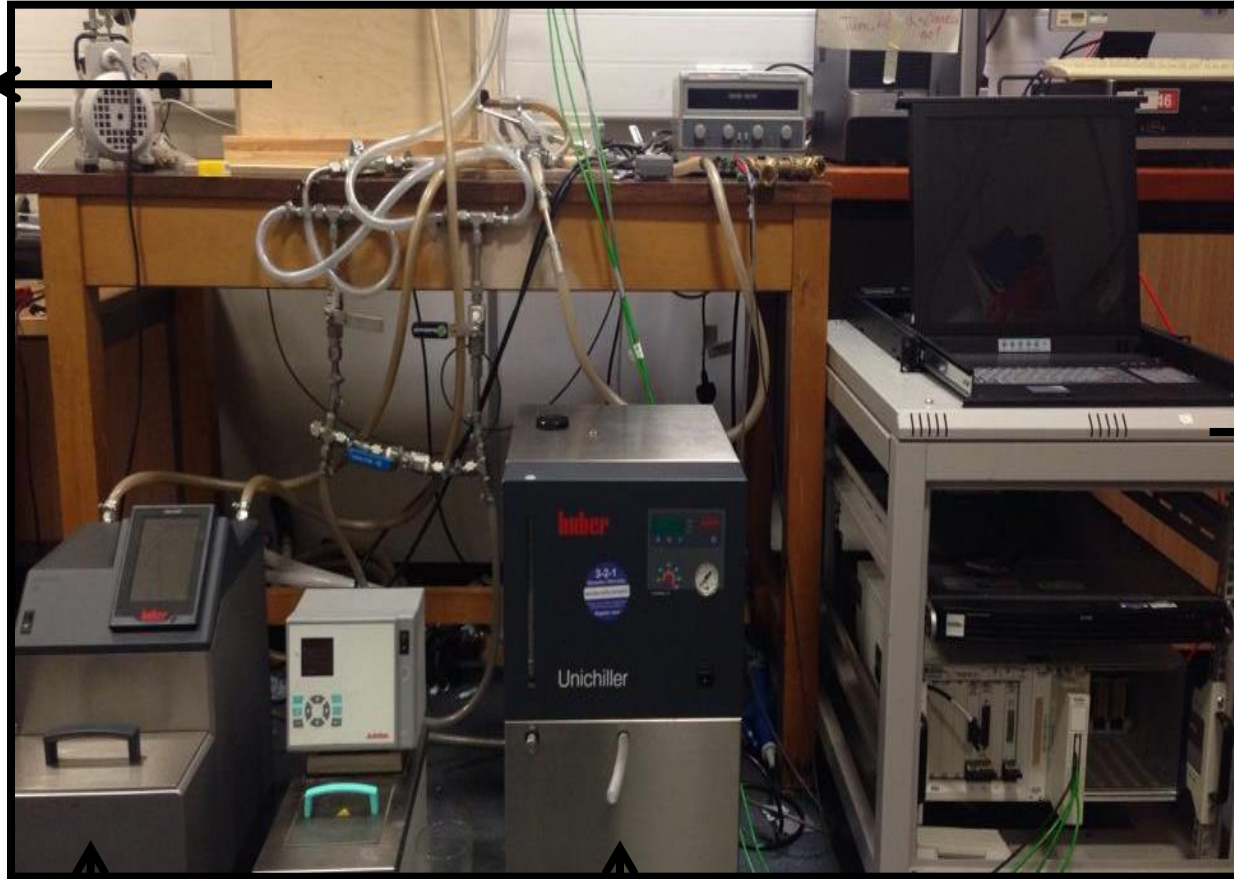
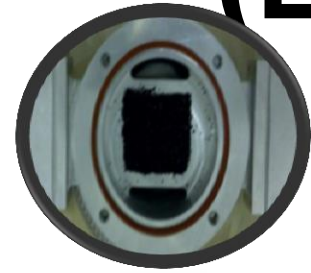

DAQ

water baths

Packing Density Effects

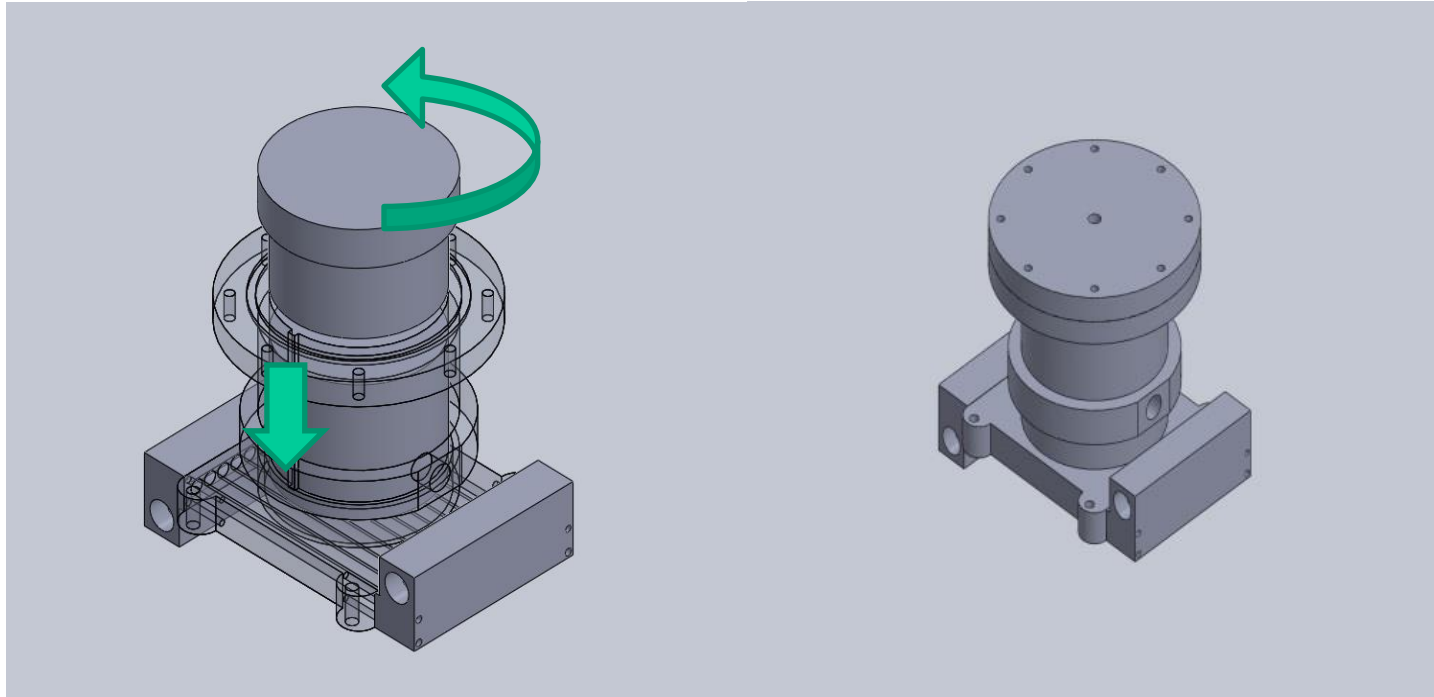

In the Future...

- Low temperature salts
- High temperature salts
- H.P design on ThermXsLab

Thanks